

Rotary cam switches
BSW 819-493-WA-12L2
Order Code: BSW0019

BALLUFF

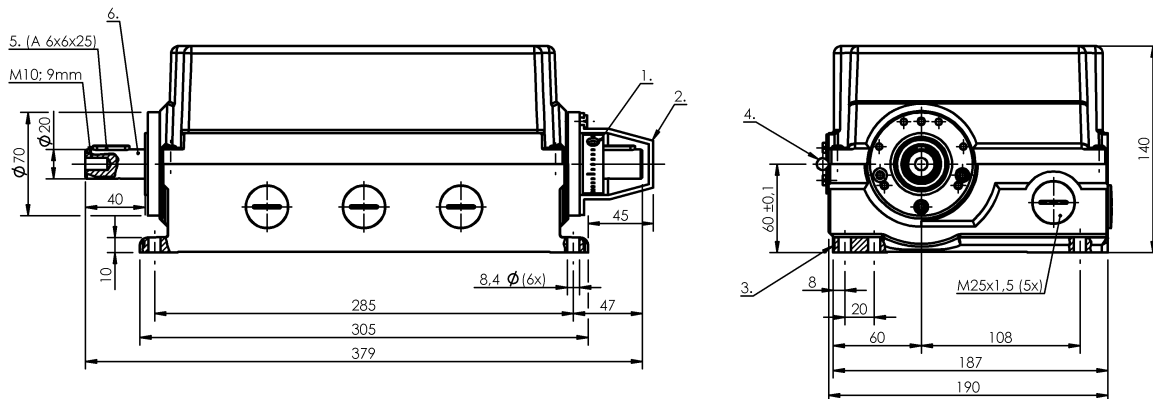

1) Scale ring, 2) Cover, 3) Reference edge, 4) Hinge, 5) Feather key, 6) Drive left-side



Basic features

Approval/Conformity	CE UKCA CCC WEEE
Basic standard	IEC 60947-5-1 IEC 60947-5-2
Operating principle	1. Switch position: Mechanical
Version	Snap contact

Electrical connection

Connection type	1. Switch position: Cable fitting via threaded insert
------------------------	---

Electrical data

Cable entries, number	5 threaded exit M25
Continuous current	1-12. Switch position: 6 A
Pulses per revolution	30
Rated operating voltage Ue	1-12. Switch position: 250 V AC
Speed max.	200 1/min
Speed monitor	Without loss of switch position

Environmental conditions

Ambient temperature	-5...80 °C
IP rating	IP65

Functional safety

B10d (EN ISO 13849-1)	BSE 44.0: 30 mil. switching cycles
BG certified	no
MTTF (40 °C)	Speed monitoring WA: 830 a

Material

Housing material	Aluminium, Anodized
Housing material, surface protection	Anodized
Material contacts	1-12. Switch position: Silver, gold plated

Mechanical data

Cam rings	1-12. Switch position: 180°
Cam rings can be secured	no
Connection cross-section	1.5 mm ²
Dimension	305 x 140 x 187 mm
Drive shaft, length	40.00 mm
Drive type	left
Life expectancy mechanical	1. Switch position: 30 mil. switching operations
Minimum torque	2.0 Nm
Mounting hold spacing B	285.0 mm
Rotation direction monitoring	no
Switching element	1-12. Switch position: BSE 44.0

Range/Distance

Opening angle min.	15°
---------------------------	-----

Wiring Diagrams

BSE 44.0

